



Creating Opportunities and Overcoming Challenges: How Abbott Nutrition's Science Drives Growth Across the Globe

*Dr. Hakim Bouzamondo,
Divisional Vice President,
Abbott Nutrition Global Research
& Development*



A Global Leader in Nutrition

More Than 40 Trusted Global Brands

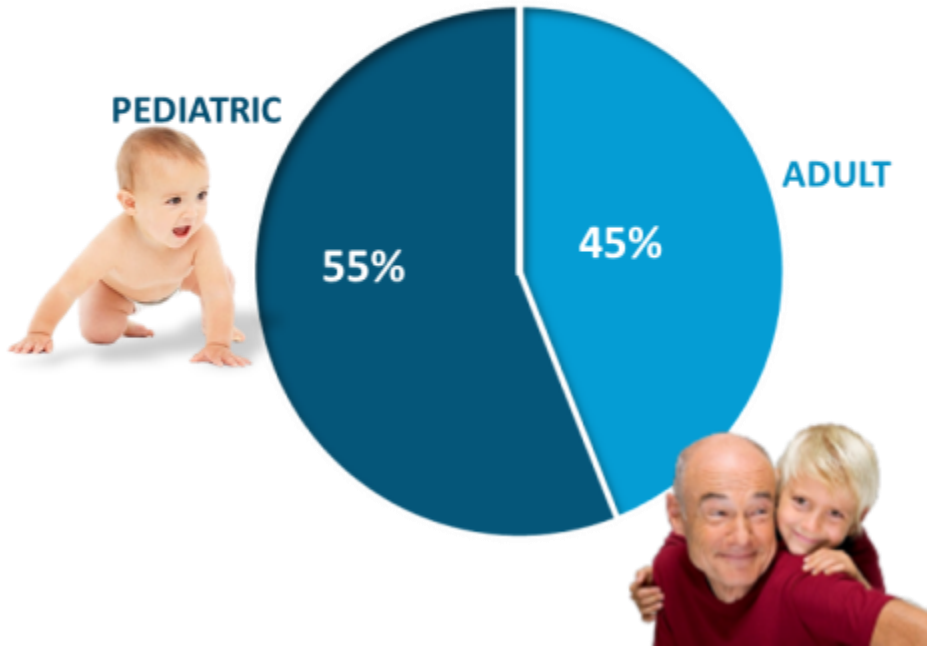

**Pediatric Nutrition –
#1 in U.S.; other geographies**

**Adult Nutrition –
#1 Globally**





An Overview of the Abbott Nutrition R&D Organization

600+

Global Scientists | Technicians



**SCIENCE-BASED
Innovation**

EXPERTISE

Nutrition Science | Physiology | Metabolism
Immunology | Clinical Science | Molecular Biology
Chemistry | Physicians | Methodology
Research Design

FOCUS

External Insights | S&T | Discovery
Clinical Studies & Education

Research Design
Chemistry | Physicians | Methodology
Immunology | Clinical Science | Molecular Biology
Nutrition Science | Physiology | Metabolism

Clinical Studies & Education
External Insights | S&T | Discovery



Innovation Is a Continuous Process

Clinical relevance to medical community and consumers

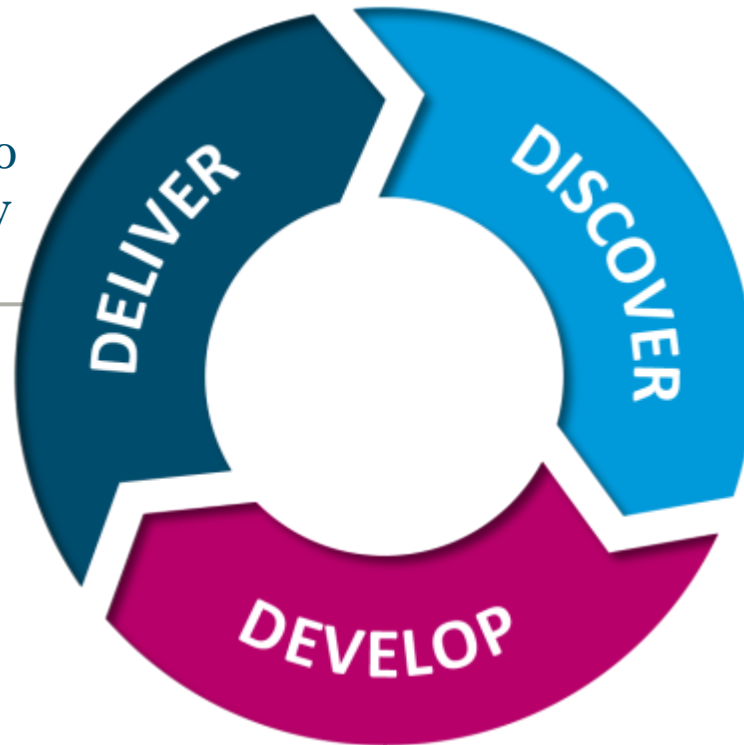

New insights and novel nutrients and mechanisms

Products that meet global health needs



The Challenge Is Finding the Right Balance



MARKET DRIVEN
Responding to consumer
insights and market needs



SCIENCE-BASED
Global innovations
taken locally

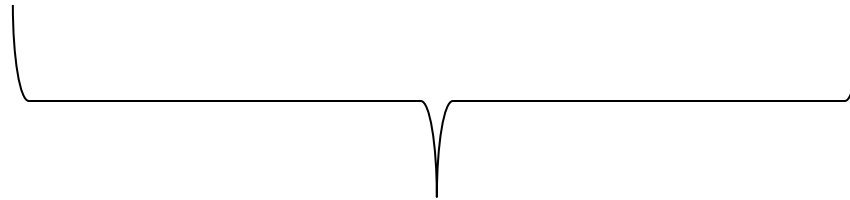

INNOVATION

80%

increase in
adults over age
60
by 2050

Trillions

Bacteria in
the gut

30-

55%
hospital
patients are
malnourished



BRAIN HEALTH



GUT HEALTH



**MOBILITY/
METABOLISM
HEALTH**



In 1974, *Nutrition Today* published “The Skeleton in the Hospital Closet” and noted “*one of the largest pockets of unrecognized malnutrition in US ... exists not in rural slums or urban ghettos but in the private rooms or wards of big city hospitals.*”

**37
YEARS**



In 1974, *Nutrition Today* published “The Skeleton in the Hospital Closet” and noted “**one of the largest pockets of unrecognized malnutrition in US ... exists not in rural slums or urban ghettos but in the private rooms or wards of big city hospitals.**”

**37
YEARS**

In 2011, an article in *Journal of Parenteral and Enteral Nutrition* stated, “**Malnutrition is a common problem in the hospital setting that often goes unrecognized by healthcare providers. Investigators have reported that malnutrition occurs in 30% to 55% of hospitalized patients.**”

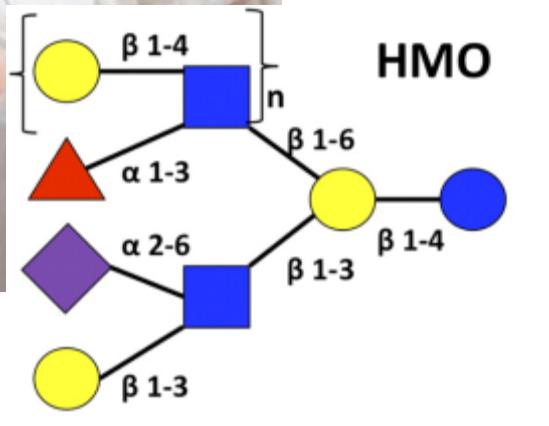







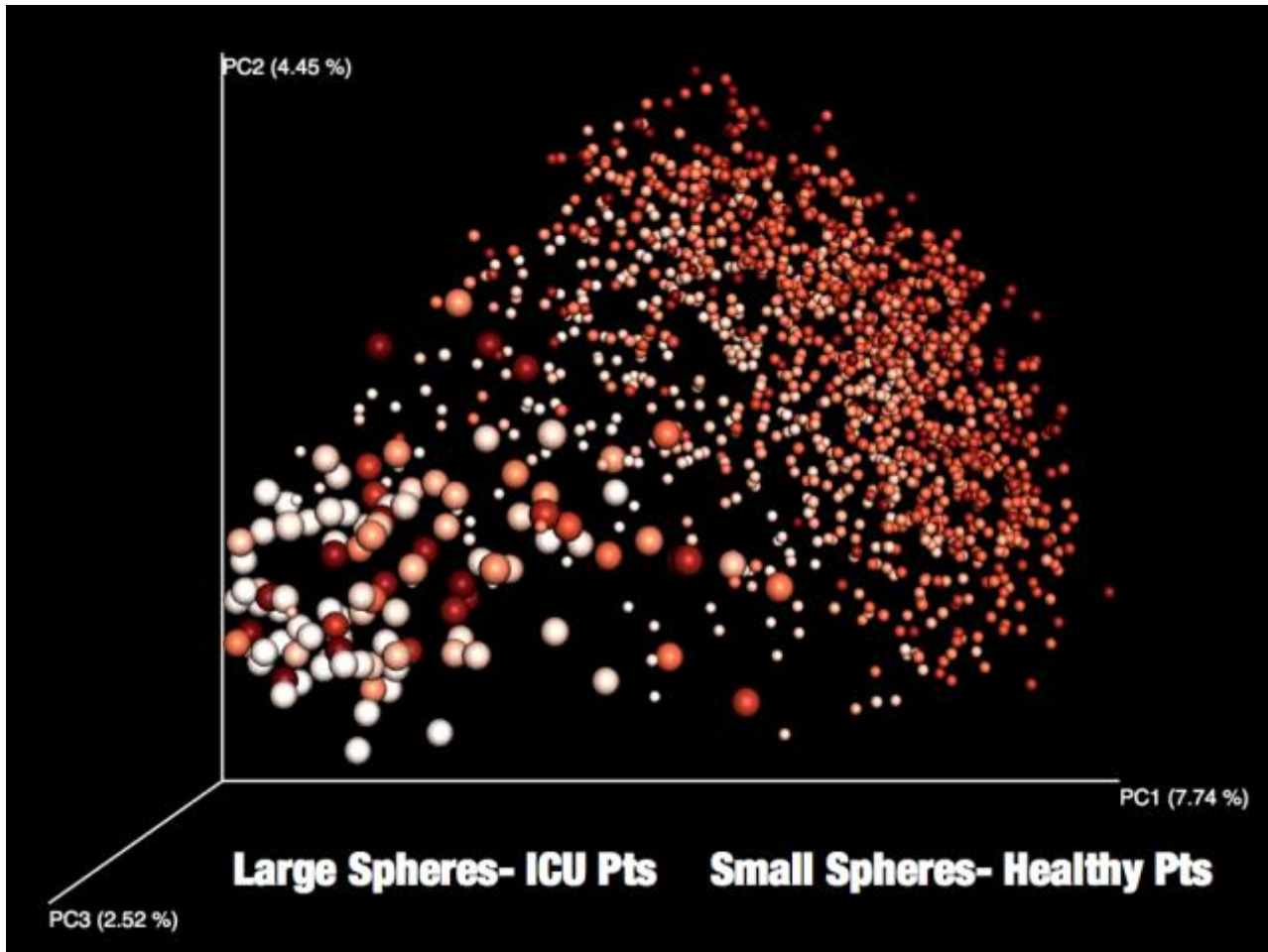

Courtesy of Dr. Paul Wischmeyer, University of Colorado

INNOVATE GLOBAL, EXECUTE LOCAL



- Act for and react to the local market
- Decision-making closer to the market means accelerates speed to market

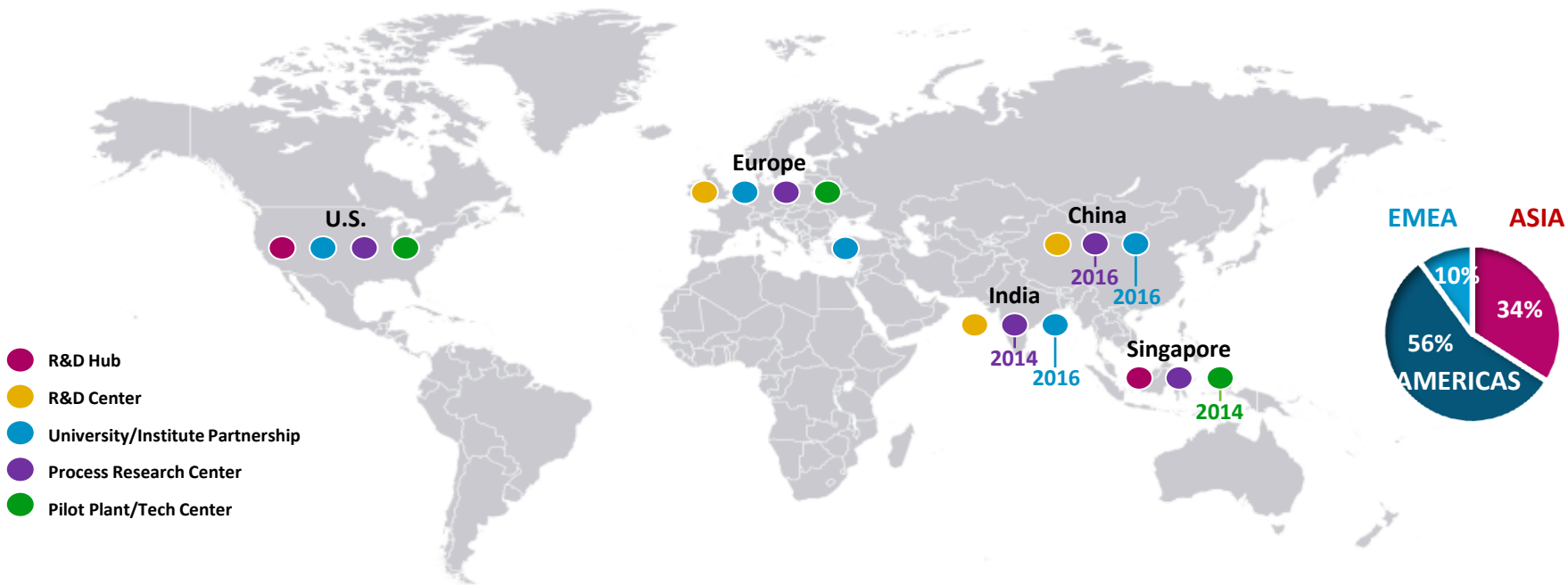
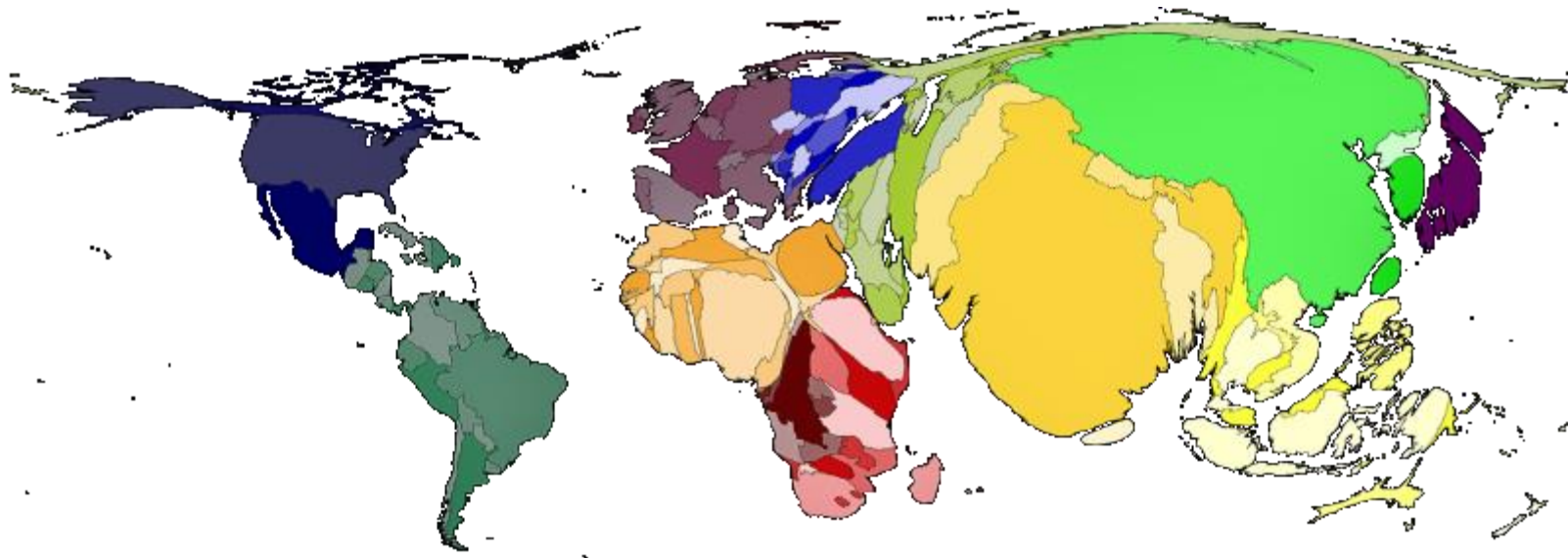

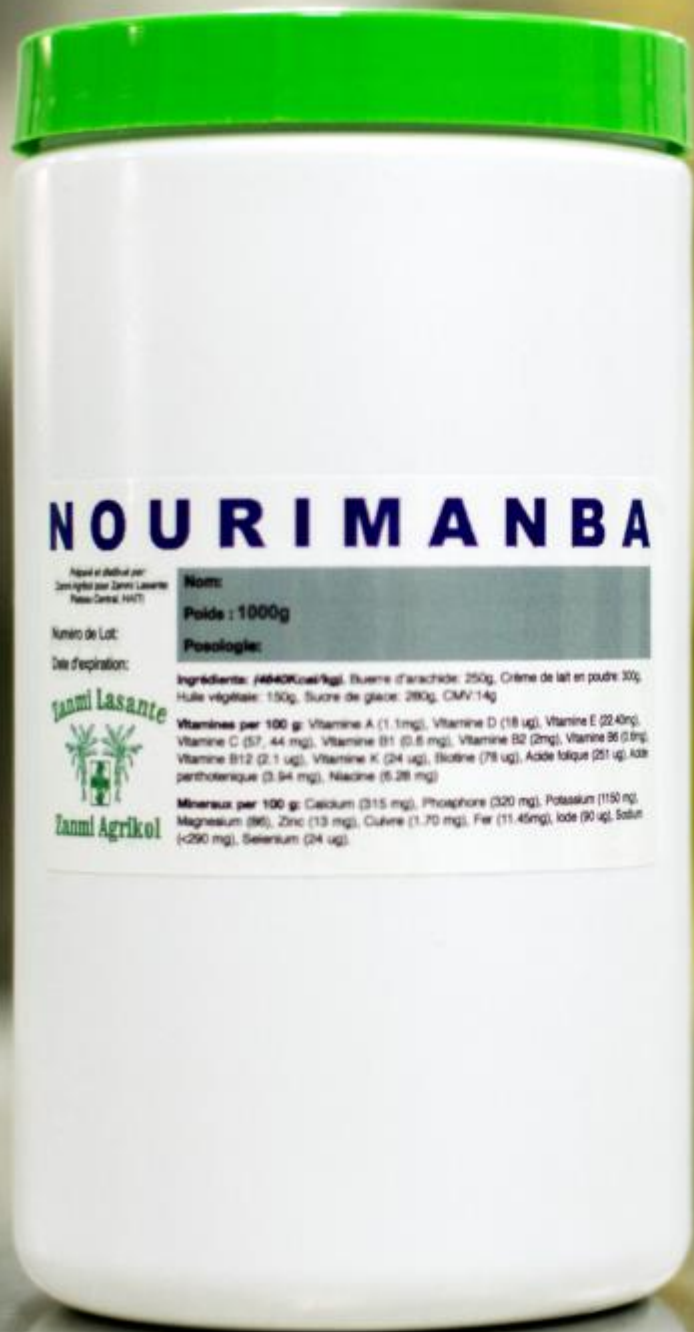





Simply
pushing
harder
within the
old
boundaries
will not do.

Karl Weick



Abbott